



CONTACTOR, AC-3 15 KW/400 V, DC 24 V, 3-POLE, SIZE S2, SCREW CONNECTION

Figure similar

product brand name	SIRIUS
Product designation	power contactor
<b>General technical data:</b>	
Size of contactor	S2
Insulation voltage	
• Rated value	690 V
Degree of pollution	3
Surge voltage resistance Rated value	6 kV
Mechanical service life (switching cycles)	
• of the contactor typical	10 000 000
• of the contactor with added electronics-compatible auxiliary switch block typical	5 000 000
• of the contactor with added auxiliary switch block typical	10 000 000
Protection class IP	
• on the front	IP00
• of the terminal	IP00
Equipment marking	
• acc. to DIN EN 61346-2	Q
• acc. to DIN EN 81346-2	Q
<b>Ambient conditions:</b>	
Installation altitude at height above sea level maximum	2 000 m
Ambient temperature	
• during operation	-25 ... +60 °C

- during storage

-55 ... +80 °C

#### Main circuit:

<b>Number of poles for main current circuit</b>	3
<b>Number of NC contacts for main contacts</b>	0
<b>Number of NO contacts for main contacts</b>	3
<b>Connectable conductor cross-section in main circuit at AC-1</b>	
<ul style="list-style-type: none"> <li>• at 60 °C minimum permissible</li> </ul>	10 mm <sup>2</sup>
<ul style="list-style-type: none"> <li>• at 40 °C minimum permissible</li> </ul>	16 mm <sup>2</sup>
<b>Operating current</b>	
<ul style="list-style-type: none"> <li>• at AC-1 at 400 V           <ul style="list-style-type: none"> <li>— at ambient temperature 40 °C Rated value</li> </ul> </li> </ul>	50 A
<ul style="list-style-type: none"> <li>• at AC-1 up to 690 V           <ul style="list-style-type: none"> <li>— at ambient temperature 40 °C Rated value</li> <li>— at ambient temperature 60 °C Rated value</li> </ul> </li> </ul>	50 A 45 A
<ul style="list-style-type: none"> <li>• at AC-3           <ul style="list-style-type: none"> <li>— at 400 V Rated value</li> <li>— at 690 V Rated value</li> </ul> </li> </ul>	32 A 20 A
<ul style="list-style-type: none"> <li>• at AC-4 at 400 V Rated value</li> </ul>	29 A
<b>Operating current for ≥ 200000 operating cycles at AC-4</b>	
<ul style="list-style-type: none"> <li>• at 400 V Rated value</li> </ul>	15.6 A
<ul style="list-style-type: none"> <li>• at 690 V Rated value</li> </ul>	11 A
<b>Operating current</b>	
<ul style="list-style-type: none"> <li>• with 1 current path at DC-1           <ul style="list-style-type: none"> <li>— at 24 V Rated value</li> <li>— at 110 V Rated value</li> </ul> </li> </ul>	45 A 4.5 A
<ul style="list-style-type: none"> <li>• with 2 current paths in series at DC-1           <ul style="list-style-type: none"> <li>— at 24 V Rated value</li> <li>— at 110 V Rated value</li> </ul> </li> </ul>	45 A 25 A
<ul style="list-style-type: none"> <li>• with 3 current paths in series at DC-1           <ul style="list-style-type: none"> <li>— at 24 V Rated value</li> <li>— at 110 V Rated value</li> </ul> </li> </ul>	45 A 45 A
<b>Operating current</b>	
<ul style="list-style-type: none"> <li>• with 1 current path at DC-3 at DC-5           <ul style="list-style-type: none"> <li>— at 24 V Rated value</li> <li>— at 110 V Rated value</li> </ul> </li> </ul>	35 A 2.5 A
<ul style="list-style-type: none"> <li>• with 2 current paths in series at DC-3 at DC-5           <ul style="list-style-type: none"> <li>— at 110 V Rated value</li> <li>— at 24 V Rated value</li> </ul> </li> </ul>	25 A 45 A
<ul style="list-style-type: none"> <li>• with 3 current paths in series at DC-3 at DC-5</li> </ul>	

— at 110 V Rated value	45 A
— at 24 V Rated value	45 A
<b>Operating power</b>	
• at AC-1	
— at 230 V at 60 °C Rated value	18 kW
— at 690 V at 60 °C Rated value	54 kW
<b>Operating power for ≥ 200000 operating cycles at AC-4</b>	
• at 400 V Rated value	8.2 kW
• at 690 V Rated value	10 kW
<b>Thermal short-time current restricted to 10 s</b>	320 A
<b>Active power loss at AC-3 at 400 V for rated value of the operating current per conductor</b>	1.8 W
<b>No-load switching frequency</b>	
• for DC	1 500 1/h
<b>Operating frequency</b>	
• at AC-1 maximum	1 200 1/h
• at AC-2 maximum	750 1/h
• at AC-3 maximum	1 000 1/h
• at AC-4 maximum	250 1/h

#### Control circuit/ Control:

<b>Type of voltage of the control supply voltage</b>	DC
<b>Control supply voltage for DC</b>	
• Rated value	24 V
<b>Operating range factor control supply voltage rated value of the magnet coil for DC</b>	0.8 ... 1.1
<b>Closing power of the magnet coil for DC</b>	13.3 W
<b>Holding power of the magnet coil for DC</b>	13.3 W
<b>Closing delay</b>	
• for DC	50 ... 95 ms
<b>Arcing time</b>	10 ... 15 ms

#### Auxiliary circuit:

<b>Number of NC contacts</b>	
• for auxiliary contacts	
— instantaneous contact	0
<b>Number of NO contacts</b>	
• for auxiliary contacts	
— instantaneous contact	0
<b>Operating current at AC-12 maximum</b>	10 A
<b>Operating current at AC-15</b>	
• at 230 V Rated value	6 A
• at 400 V Rated value	3 A

<b>Operating current at DC-12</b>	
<ul style="list-style-type: none"> <li>• at 60 V Rated value</li> <li>• at 110 V Rated value</li> <li>• at 220 V Rated value</li> </ul>	<p>6 A</p> <p>3 A</p> <p>1 A</p>
<b>Operating current at DC-13</b>	
<ul style="list-style-type: none"> <li>• at 24 V Rated value</li> <li>• at 60 V Rated value</li> <li>• at 110 V Rated value</li> <li>• at 220 V Rated value</li> </ul>	<p>10 A</p> <p>2 A</p> <p>1 A</p> <p>0.3 A</p>
<b>Contact reliability of the auxiliary contacts</b>	1 faulty switching per 100 million (17 V, 1 mA)

#### UL/CSA ratings:

<b>Contact rating of the auxiliary contacts acc. to UL</b>	A600 / Q600
--	-------------

#### Short-circuit:

<b>Design of the fuse link</b>	
<ul style="list-style-type: none"> <li>• for short-circuit protection of the main circuit <ul style="list-style-type: none"> <li>— with type of assignment 1 required</li> <li>— with type of assignment 2 required</li> </ul> </li> <li>• for short-circuit protection of the auxiliary switch required</li> </ul>	<p>fuse gL/gG: 125 A</p> <p>fuse gL/gG: 63 A</p> <p>fuse gL/gG: 10 A</p>

#### Installation/ mounting/ dimensions:

<b>Mounting type</b>	screw and snap-on mounting onto 35 mm standard mounting rail according to DIN EN 50022
<ul style="list-style-type: none"> <li>• Side-by-side mounting</li> </ul>	Yes
<b>Height</b>	112 mm
<b>Width</b>	55 mm
<b>Depth</b>	130 mm
<b>Required spacing</b>	
<ul style="list-style-type: none"> <li>• for grounded parts <ul style="list-style-type: none"> <li>— at the side</li> </ul> </li> </ul>	6 mm

#### Connections/ Terminals:

<b>Type of electrical connection</b>	
<ul style="list-style-type: none"> <li>• for main current circuit</li> <li>• for auxiliary and control current circuit</li> </ul>	<p>screw-type terminals</p> <p>screw-type terminals</p>
<b>Type of connectable conductor cross-section</b>	
<ul style="list-style-type: none"> <li>• for main contacts <ul style="list-style-type: none"> <li>— solid</li> <li>— stranded</li> <li>— single or multi-stranded</li> <li>— finely stranded with core end processing</li> <li>— finely stranded without core end processing</li> </ul> </li> </ul>	<p>2x (0.75 ... 16 mm<sup>2</sup>)</p> <p>2x (0.75 ... 25 mm<sup>2</sup>)</p> <p>2x (0,75 ... 16 mm<sup>2</sup>)</p> <p>2x (0.75 ... 16 mm<sup>2</sup>)</p> <p>2x (0.75 ... 16 mm<sup>2</sup>)</p>

- for AWG conductors for main contacts





2x (18 ... 2)

**Type of connectable conductor cross-section**

- for auxiliary contacts
  - solid
  - finely stranded with core end processing
- for AWG conductors for auxiliary contacts





2x (0.5 ... 1.5 mm<sup>2</sup>), 2x (0.75 ... 2.5 mm<sup>2</sup>), max. 2x (0.75 ... 4 mm<sup>2</sup>)  
 2x (0.5 ... 1.5 mm<sup>2</sup>), 2x (0.75 ... 2.5 mm<sup>2</sup>)  
 2x (20 ... 16), 2x (18 ... 14), 1x 12



Certificates/ approvals:

General Product Approval		Functional Safety/Safety of Machinery	Declaration of Conformity	Test Certificates
				
CSA		UL	EG-Konf.	

[Type Examination](#)

[Special Test Certificate](#)

Test Certificates	Shipping Approval
<a href="#">Type Test Certificates/Test Report</a>	<a href="#">other</a>
	 ABS  DNV  GL  LRS

Shipping Approval	other
 RINA  RMRS	<a href="#">Confirmation</a> <a href="#">Environmental Confirmations</a> <a href="#">other</a>

Further information

**Information- and Downloadcenter (Catalogs, Brochures,...)**

<http://www.siemens.com/industrial-controls/catalogs>

**Industry Mall (Online ordering system)**

<http://www.siemens.com/industrymall>

**Cax online generator**

<http://support.automation.siemens.com/WW/CAXorder/default.aspx?lang=en&mlfb=3RT10341BB40>

**Service&Support (Manuals, Certificates, Characteristics, FAQs,...)**

<https://support.industry.siemens.com/cs/ww/en/ps/3RT10341BB40>

**Image database (product images, 2D dimension drawings, 3D models, device circuit diagrams, EPLAN macros, ...)**

[http://www.automation.siemens.com/bilddb/cax\\_de.aspx?mlfb=3RT10341BB40&lang=en](http://www.automation.siemens.com/bilddb/cax_de.aspx?mlfb=3RT10341BB40&lang=en)

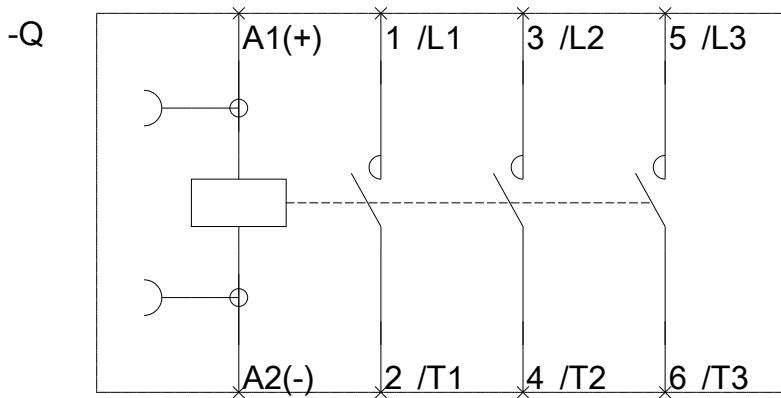
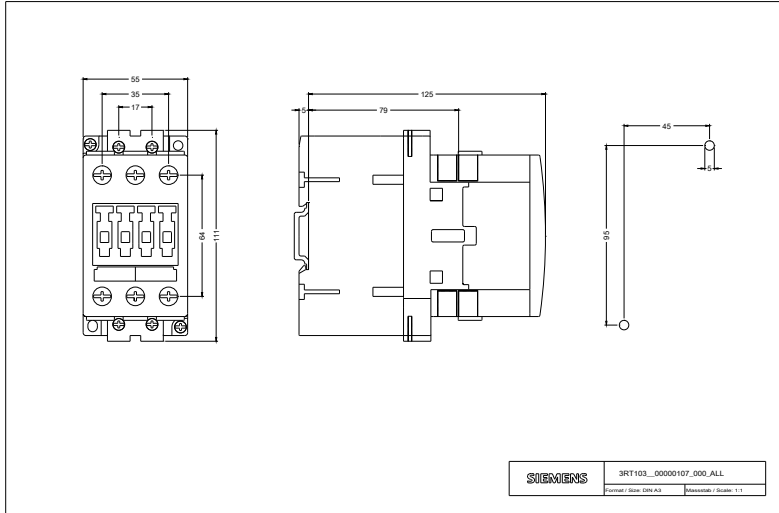

last modified:

02.06.2015